

Installation Guide / Manual (ECO-1515 to ECO-2418)

ESC+

Warning

Caution with main supply and live wires. Install with qualified technician or trained personnel.

Universal Bracket can be used for any type of installation as shown below.

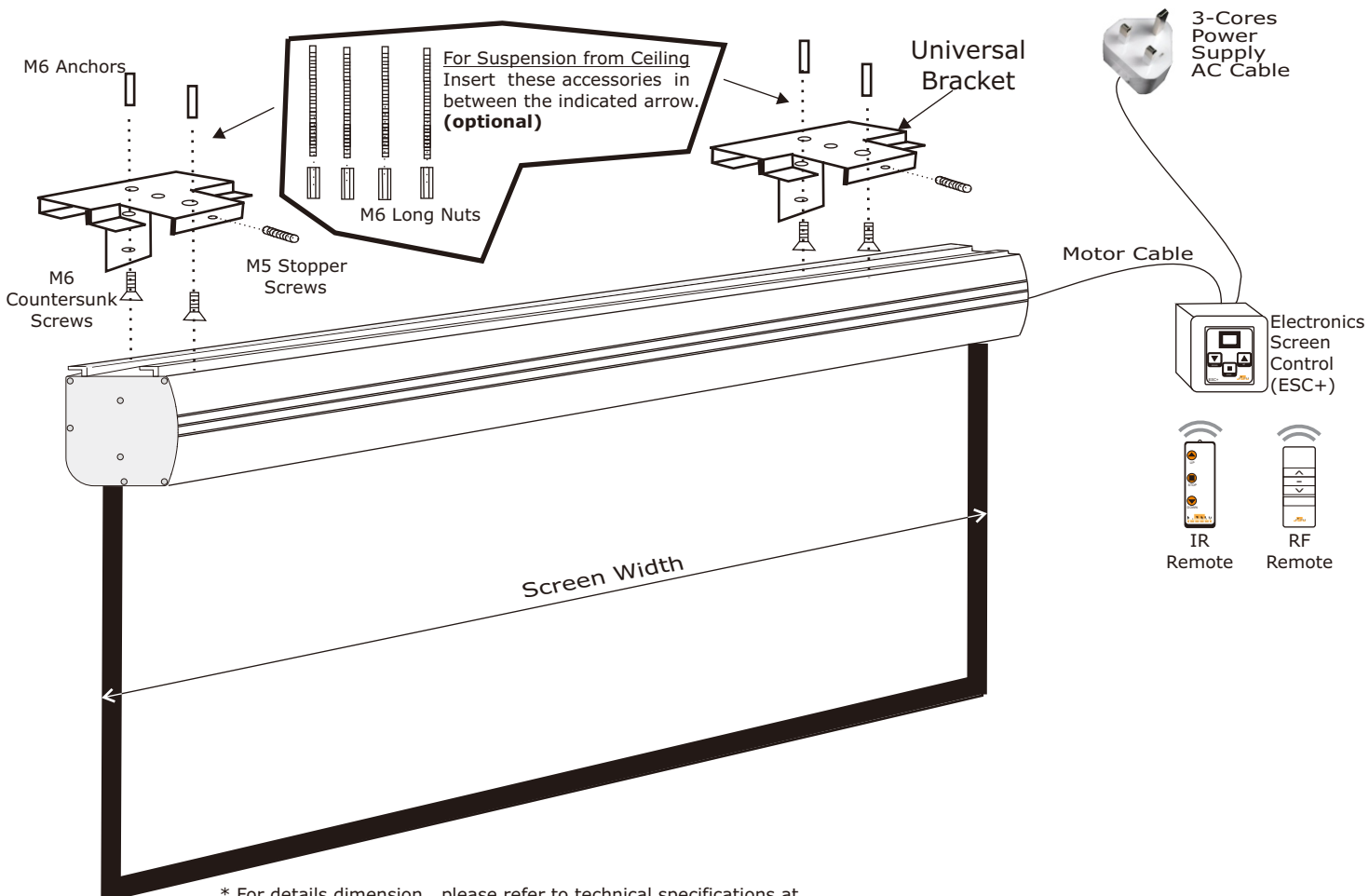
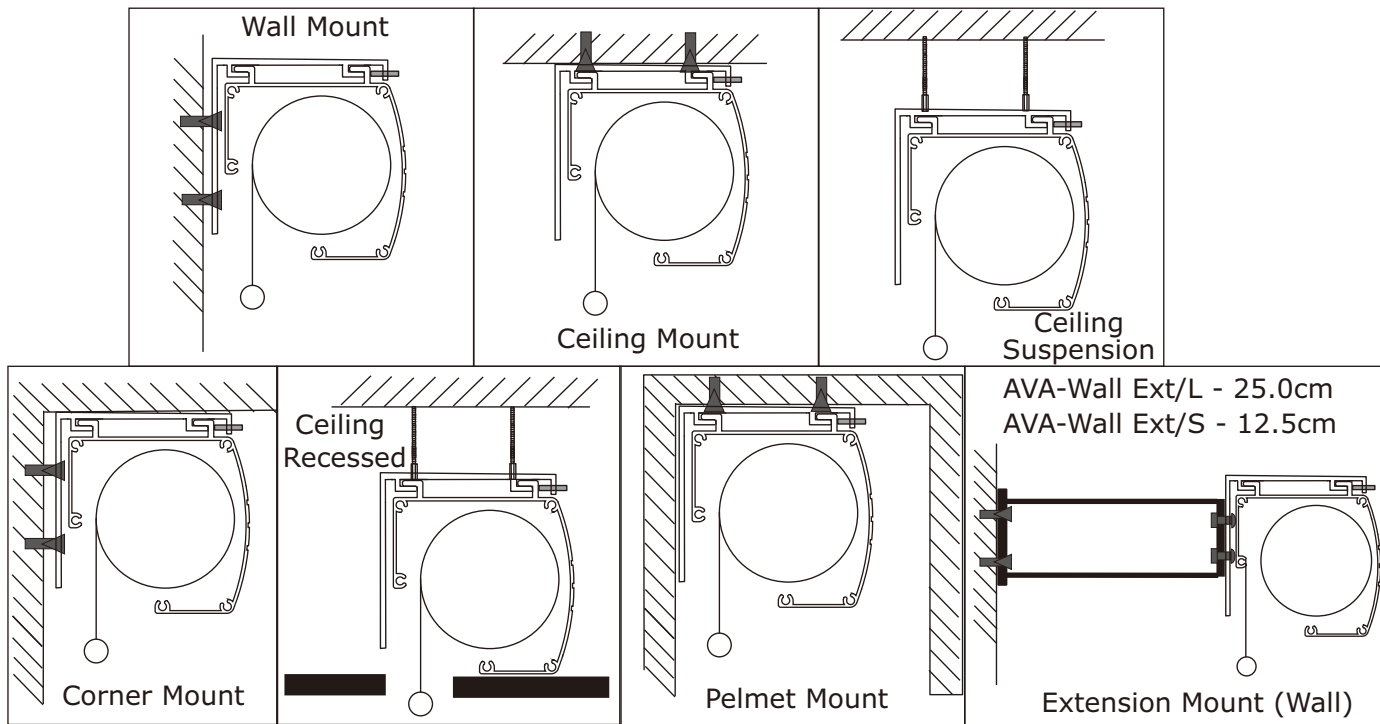

* For details dimension , please refer to technical specifications at www.remacotech.com

STEP 1

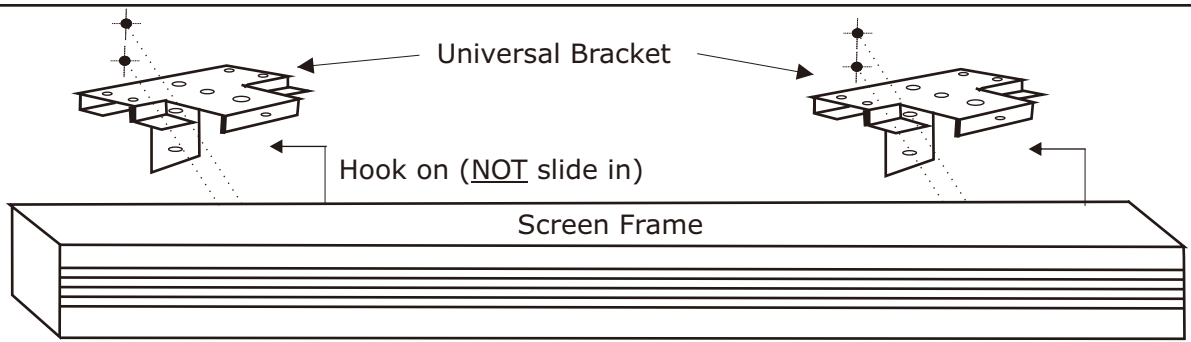

A) Mark the bracket position with the help of universal bracket.

STEP 2

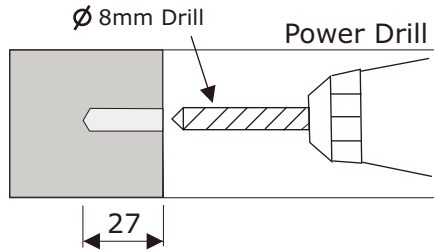

B) Drill Diameter 8mm Holes to a depth 27mm.

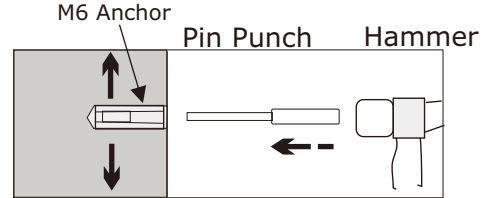

C) Insert M6 Anchor into the hole.
D) Use pin punch to expand the anchor.

STEP 3

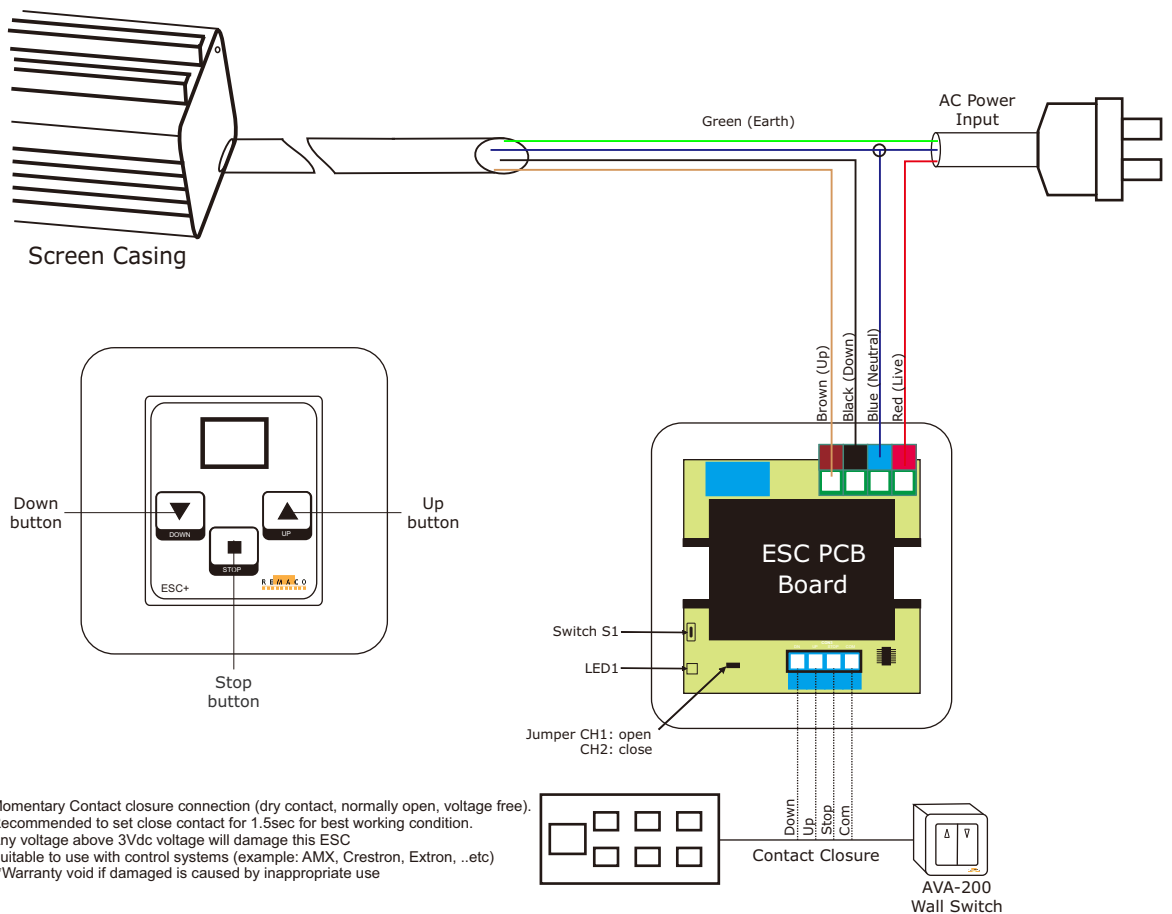

OPTION-1

ESC+ compatible with AVA-300 1-Channel Infrared Remote Control

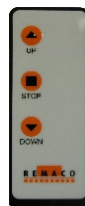

AVA-300 Infrared Remote Control

OPTION-2 ESC+ compatible with AVA-315 1-Channel Radio Frequency Remote



AVA-315
Radio Frequency Remote

Pairing ESC+ with AVA-315 1-Ch

Learning Mode

Step1. Press and Hold Switch S1 for 4 seconds.

Step2. Release Switch S1 and motor step-move up/down, LED1 flash slowly.

Step3. Press UP button on the RF remote, motor step-move again and stop.

Step4. LED1 off and "Learning" is completed successfully.

* NOTE: Make sure RF remote control is set close to ESC+ not further 20cm.

**NOTE: If nothing is pressed within 20seconds, the learning mode will disable and back to normal mode.

Delete Mode

Step1. Press and Hold Switch S1 until the LED1 flash fast.

Step2. Release Switch S1.

Step3. Press Switch S1 again within 7seconds.

Step4. LED1 off, "Delete" mode is completed successfully.

STEP 4

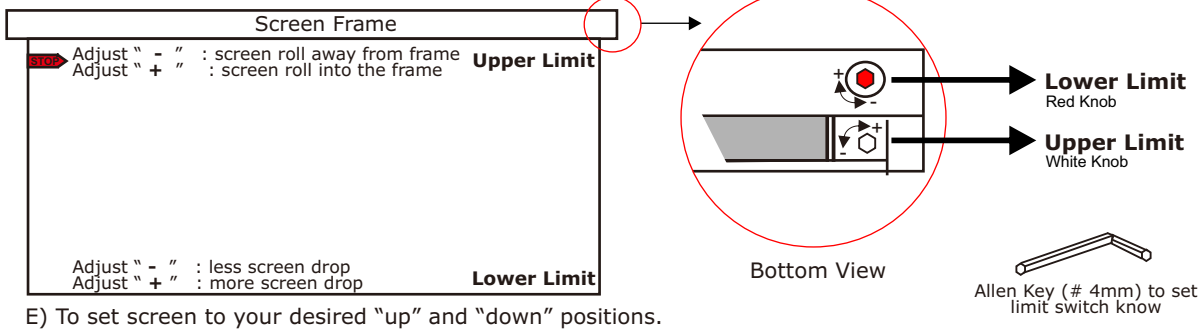

Important Note

The upper limit and lower limit of the screen had been preset in factory. Any adjustment to these 2 limit switches may cause damages to the screen fabric. If adjusted, it will cause the following problems:

- The screen will roll into the frame and stop by force and not by the Upper Limit switch. This will cause overheating of motor which unable the screen to operate properly.
- The depression of the bottom bar onto the fabric will cause horizontal mark on screen surface.
- Adjusting the Lower Limit of the screen any lower than beyond the STOP sticker may cause the fabric to drop off

Disclaimer

Any adjustment to these 2 limit switches will void the warranty for the screen and Remaco will hold no responsibility for any damages to it. Please consult us if it is necessary to do any adjustment to the limit switch.

End